

# THE HQ-170 COMMUNICATIONS RECEIVER

INSTRUCTION AND SERVICE INFORMATION

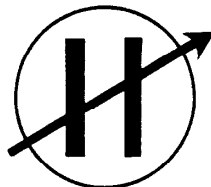

ESTABLISHED 1910

ISSUE NO. 2

In order to receive the full unconditional 90-day warranty against defective material and workmanship in this receiver, the warranty card must be filled out and mailed within two weeks of purchase. Please refer to serial number of warranty in correspondence.

**THE HAMMARLUND MANUFACTURING CO., INC.**  
460 West 34th Street : : : : New York 1, N.Y.

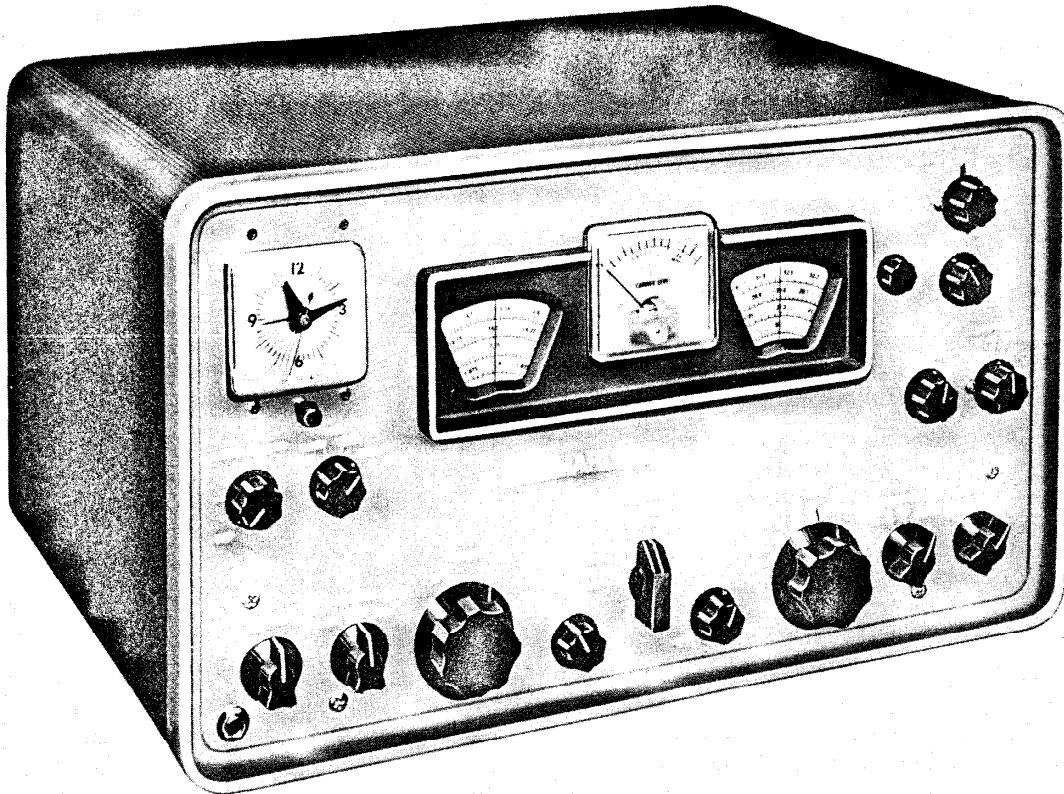

Figure 1. The HQ-170 Communications Receiver

### TUBE COMPLEMENT

SYMBOL	TYPE	TUBE	FUNCTION
V1	6BZ6	Pentode	RF Amplifier
V2	6BE6	Pentagrid Converter	1st Mixer
V3	6BE6	Pentagrid Converter	Converter or 455 Kcs IF Amplifier
V4	6BA6	Pentode	455 Kcs IF Amplifier
V5	6BE6	Pentagrid Converter	Converter
V6	6BA6	Pentode	60 Kcs IF Amplifier
V7	6BA6	Pentode	60 Kcs IF Amplifier
V8	6BV8	Double Diode-Triode	60 Kcs IF Amplifier, AVC, AM Det.
V9	12AU7	Double Triode	SSB Product Detector
V10	6AL5	Double Diode	Noise Limiter
V11	6BZ6	Pentode	Crystal Calibrator Oscillator
V12	6C4	Triode	High Frequency Oscillator
V13	12AU7	Double Triode	60 Kcs BFO, "S" Meter Amplifier
V14	OB2	Gas Filled Diode	Voltage Regulator
V15	5U4-GB	Twin Diode	Rectifier
V16	6AV6	Double Diode-Triode	First AF Amplifier, Delayed AVC Gate
V17	6AQ5	Pentode	AF Output



## INTRODUCTION

The entirely new HQ-170 amateur band communications receiver incorporates many features that will enable you to maintain reliable contact with your fellow hams under the most difficult conditions. It will provide years of top performance with a minimum of maintenance. The HQ-170 has a self-contained power supply operating from a 60 cps, 105-125 volt a-c source. The model HQ-170C incorporates a telechron automatic electric clock timer in its design. The export model, HQ-170E, will operate from a 50-60 cps, 115-230 volt a-c source. Because of the power supply

operating frequency and voltage of the export model, the clock (automatic timer) is not incorporated in this model. Approximate power consumption 120 watts.

The HQ-170 is a seventeen tube triple conversion superheterodyne receiver (double conversion on the 160 and 80 meter bands) that has been designed to provide the best possible performance for reception of AM, SSB and CW signals. The most important performance characteristics of an amateur receiver have been made adjustable by means of the front panel knobs.

The precise RF tuning system covers the following amateur bands:

160 meter band .....	1.8 to 2.0 mc .....	calibrated in 5KCS divisions
80 meter band .....	3.5 to 4.0 mc .....	calibrated in 5KCS divisions
40 meter band .....	7.0 to 7.3 mc .....	calibrated in 5KCS divisions
20 meter band .....	14.0 to 14.4 mc .....	calibrated in 5KCS divisions
15 meter band .....	21.0 to 21.6 mc .....	calibrated in 10KCS divisions
10 meter band .....	28.0 to 30.0 mc .....	calibrated in 20KCS divisions
6 meter band .....	50.0 to 54.0 mc .....	calibrated in 50KCS divisions

A 100 division, 0 to 100 arbitrary scale is provided. Supplementing the main single control RF tuning, is a vernier tuning control which is extremely valuable in "zeroing in" single sideband signals.

A built-in 100Kcs crystal calibrator provides marker signals at every 100Kcs on all bands for checking dial calibration accuracy. The dial calibration reset knob enables you to adjust the frequency calibration to approach frequency meter standards on each band.

A tuned RF stage with the addition of an antenna trimmer assures maximum sensitivity and a high signal to noise ratio for outstanding reception of weak and distant signals. A manual sensitivity (RF gain) control prevents overloading by strong signals.

The most most prominent features in the HQ-170 receiver are the selectivity and sideband selectors. They enable you to adjust for optimum reception under the most adverse conditions with each type of signal. The panel knob indicates fixed and precisely known bandwidths approaching mechanical filter type of skirt selectivity.

One special feature of the HQ-170 is a "razor sharp" adjustable slot filter to eliminate co-channel interference. A single knob controls the filter and provides up to 40 db attenuation of the unwanted

signals over a range of 10 Kcs. In addition, the slot depth control may be used to obtain an additional 20 db rejection at any one single frequency.

To compensate for wide input signal variation, the receiver incorporates a fast attack (charge), adjustable decay AVC and switch with OFF-SLOW-MEDIUM-FAST positions suitable for all types of reception.

CW and SSB signals are detected by a separate linear product detector for the highest signal to noise ratio and freedom from interference.

A continuously variable (audio type) noise limiter provides freedom from both positive and negative noise pulses.

The "S" meter indicates carrier level on all types of reception (including all positions of AVC). It is calibrated for AM signals with the AVC on SLOW-MEDIUM-FAST to indicate the accuracy of tuning and the relative strength.

The receiver possesses the Auto Response feature which automatically narrows and widens the frequency range of the audio output, according to the gain required. This feature permits higher fidelity reception on stronger signals, while providing the sharp cut-off required in receiving communications under adverse conditions. A second advantage of the Hammarlund Auto-Response is the rapid damping of the audio power in the



speaker voice coil which greatly minimizes undesirable speaker "hangover". The receiver may be used with either speaker or headphones. AC hum is made inaudible by means of adequate filtering.

Large comfortable controls in logical groupings

are provided for greatest operating ease. The new futuristic front panel is clearly marked to permit full attention to the operation at hand.

The HQ-170 was designed with you in mind. You will have many hours of pleasure in operating this truly fine communications instrument.

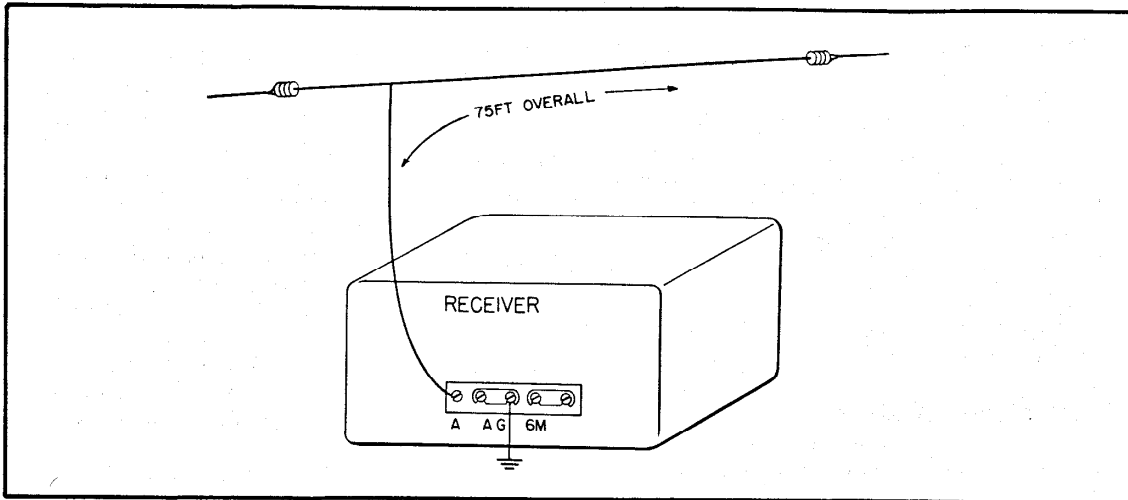

Figure 2. Single Wire Antenna Connections (all bands)

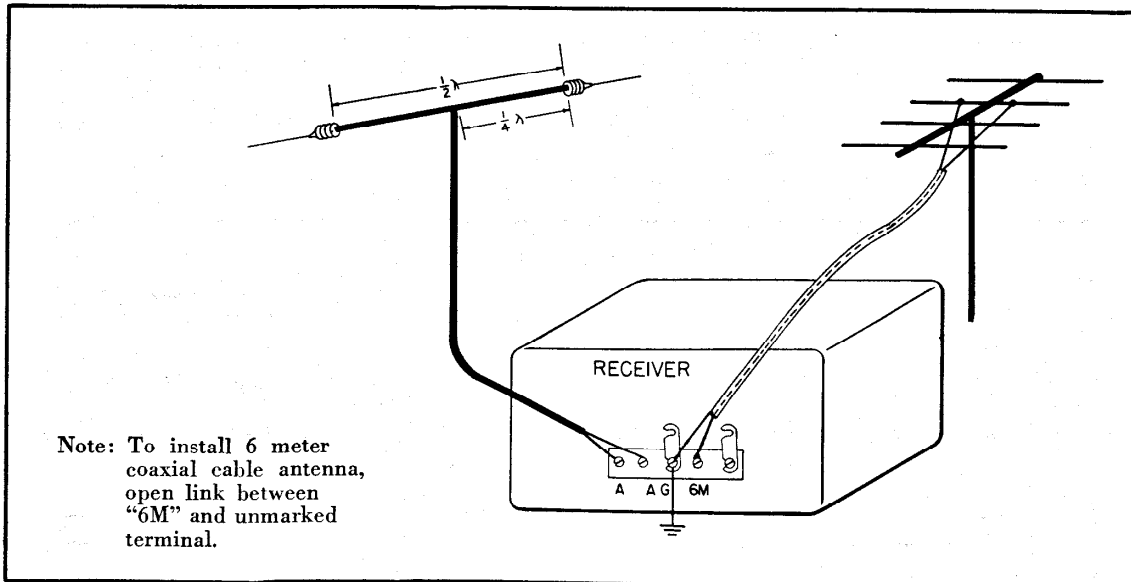

Figure 3. Balanced Transmission Line Antenna Connections (all bands with optional separate 6 meter band antenna shown)



## INSTALLATION

### UNPACKING.

Unpack the receiver carefully. Make sure the tubes, associated tube shields and pilot lamps are in place.

### SPEAKER CONNECTION.

Connect a 3.2 ohm permanent magnet dynamic speaker (Hammarlund Matched Speaker) to the two terminals marked SPKR on the rear of the chassis (see Figure 4). For best performance do not place speaker on top of receiver cabinet.

### POWER CONNECTIONS.

Before inserting attachment plug into power outlet, make certain power source is of proper voltage and frequency. (Refer to paragraph one of Introduction.)

### INSTALLING ANTENNA.

The HQ-170 is designed to operate with either single wire antenna or a balanced transmission line type. In addition, a separate 6 meter (50-54 Mcs) coaxial cable antenna may be connected to achieve the utmost in receiver performance on this band.

To install a separate 6 meter antenna, open the link connecting the "6M" and the unmarked terminal on the rear of the receiver and connect the inner conductor of the coaxial cable to "6M" and the outer braid to the "G" terminal. The single wire or balanced antenna for the remaining bands is connected as shown in Figure 2 or 3.

The front panel antenna trimmer control (Figure 5) permits a good impedance match to most antenna systems of 50 to 600 ohms (on all bands).

For general coverage, single wire antenna of 20 to 50 feet length will provide surprisingly good reception. A long single wire outdoor antenna, such as the one shown in Figure 2, will generally provide entirely satisfactory performance. This wire may be 50 to 150 feet long.

For best reception, the antenna should be isolated as much as possible from neighboring objects and at right angles to the power lines or busy highways so as to minimize interference pickups.

Optimum performance on a particular amateur band or other narrow tuning range will be obtained by using a tuned half-wave dipole or folded dipole using a 300 ohm transmission line or other suitable lead-in, as shown in Figure 3.

To tune the one-half wave length dipole use the following formula to determine the length of the antenna:

$$\text{Length (feet)} = \frac{468}{\text{Freq. (Mcs)}}$$

Each arm (1/4 wave length) is half the length obtained from the above formula.

A good ground, although not always necessary, will generally aid reception and reduce stray line hum.

In some locations further line hum reduction may be obtained by reversing polarity of the power cord plug.

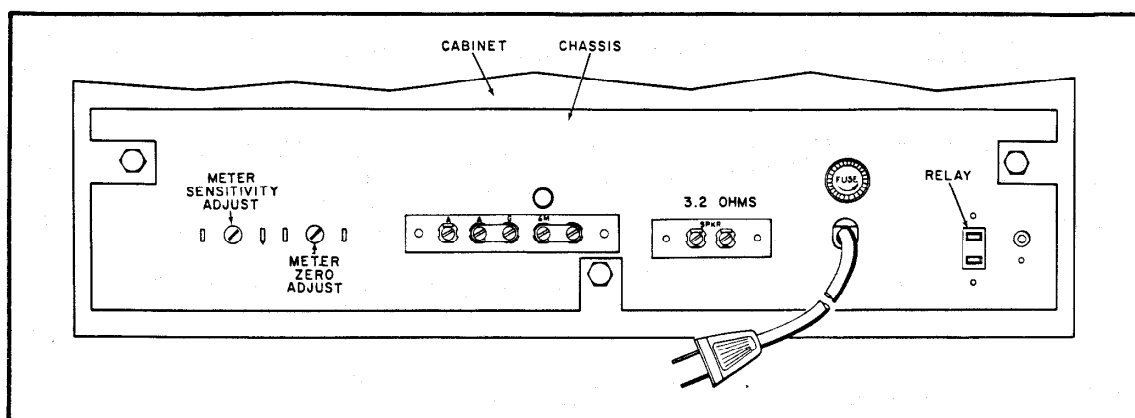

Figure 4. Connection Points at Rear of Chassis

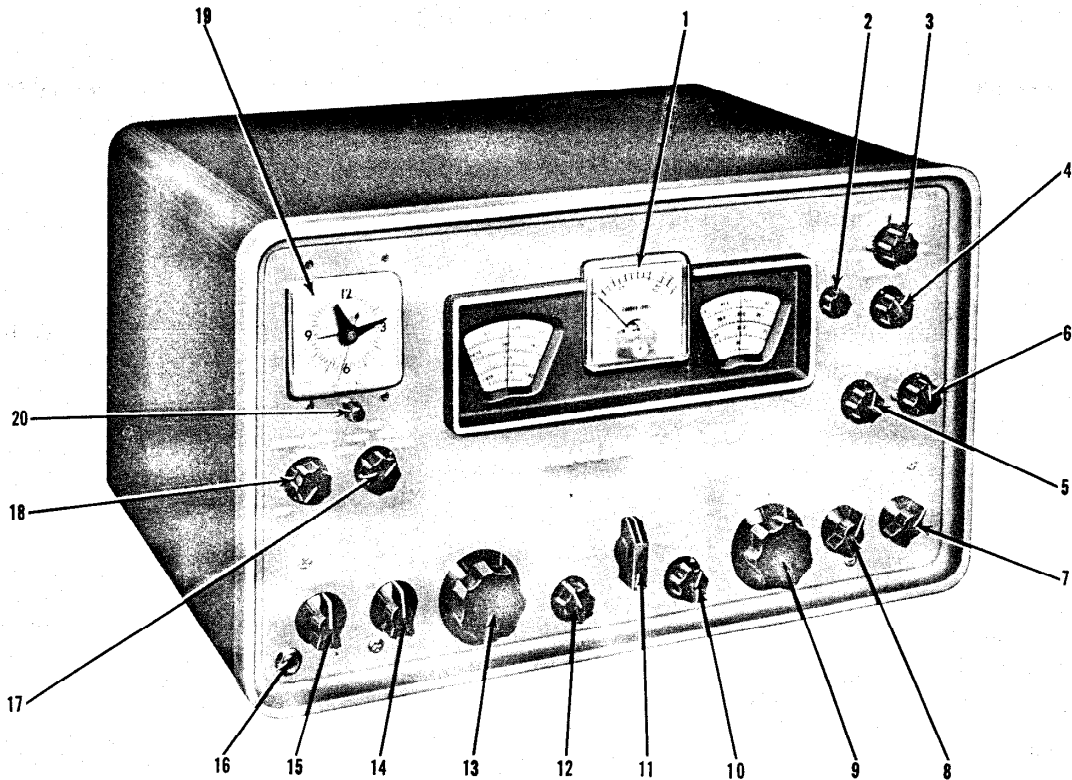

Figure 5. Location of Controls

- |   |  |
|---|--|
| 1. "S" Meter Carrier Level                      | 12. Audio Frequency Gain Control                 |
| 2. Calibration Set Control                      | 13. Main Tuning Control                          |
| 3. Slot Frequency Control                       | 14. Function Switch (Send-Receive-Calibrator)    |
| 4. Slot Depth Control                           | 15. Antenna Trimmer                              |
| 5. Function Switch (Type of Reception)          | 16. Phone Jack (Output for Head-phone Operation) |
| 6. Beat Frequency Oscillator Control (CW Pitch) | 17. AVC Time Constant Selector                   |
| 7. Bandwidth Selector                           | 18. Noise Limiter Level Control with Switch      |
| 8. Sideband Selector                            | 19. Telechron Automatic Clock (Timer)            |
| 9. Vernier Tuning Control                       | 20. Timer Switch                                 |
| 10. RF Sensitivity Control                      |  |
| 11. Tuning Range Switch (Band Selector)         |  |



## OPERATION

### AM RECEPTION.

For AM reception the position of controls nominally should be as follows:

Function Switch .....	AM
Send-Receive-Cal Switch .....	Receive
Selectivity Switch .....	*3 Kcs
Sideband Switch .....	Both
Vernier Tuning Control .....	0
Beat Frequency Oscillator Control .....	0
Slot Frequency Control .....	***Counter Clockwise
Slot Depth Control .....	****Center
Cal Set Control .....	Set to Vertical Marker
RF (Sensitivity) Control .....	**Fully Clockwise
AF (Gain) Control .....	*****Adjust to desired level
Tuning Range Switch .....	Set to desired Frequency range
Main Tuning Control .....	Tune for highest "S" meter reading
Antenna Trimmer .....	Tune for highest "S" meter reading
AVC Time Constant .....	Slow or medium
Noise Limiter Level .....	Off
Timer Switch .....	On

\* To obtain maximum fidelity in AM reception, the widest bandwidth is normally used. However, under conditions of severe interference from spurious signals or atmospheric noise, the bandwidth is reduced to improve intelligibility although some sacrifice of fidelity results. Adjust bandwidth for best reception.

\*\* For normal AM reception, the RF gain control is rotated fully clockwise. The "S" meter calibration holds only when the AVC switch is on SLOW-MEDIUM or FAST. In the presence of extremely strong signals, the sensitivity control may be reduced to prevent overload.

\*\*\* The Slot frequency control provides an extremely sharp adjustable slot or hole in the selectivity curve (see Figure 6). It is normally located outside of the passband of the 2nd IF (455 Kcs). It is brought into the passband for the purpose of eliminating interference from heterodyne

signals on AM and monkey chatter on SSB. On CW Reception, the slot filter will materially aid in reducing or eliminating adjacent or co-channel interference.

### CAUTION

*When tuning the receiver across any band, make certain that the Slot Frequency control is at the 5 Kcs position, not on "0".*

\*\*\*\* In many cases additional rejection to interference will be needed. The Slot depth control is used to provide the required additional attenuation at the slot frequency position. Adjust the control for the greatest reduction in the interference.

\*\*\*\*\* A feature of the audio system is the variable negative feedback employed. Maximum feedback is provided at low settings of the Audio Gain Control for the best quality reception of strong signals. As the Audio Gain Control is increased, the feedback decreases to provide additional selectivity by the audio system for reception of weak signals. This results in an increased signal to noise ratio. A further advantage is the critical damping of the speaker for elimination of speaker "hangover." This upgrades the reception of speech and decreases receiver output noise. Another advantage is the reduction of distortion at low settings of the Audio Gain Control.

### CODE SIGNAL RECEPTION.

For CW code reception the position of the controls nominally should be as follows:

Function Switch .....	CW-SSB
Send-Receive-Cal Switch .....	Receive
Selectivity Switch .....	3 Kcs or less
Sideband Switch .....	Both
Vernier Tuning Control .....	0
Beat Frequency Oscillator Control .....	Adjust to desired pitch
Slot Frequency Control .....	Counter clockwise
Slot Depth Control .....	Center
Cal Set Control .....	Set to vertical marker
RF (Sensitivity) Control .....	Adjust to desired level
AF (Gain) Control .....	Adjust to desired level
Tuning Range Switch .....	Set to desired frequency range



Main Tuning Control .....	Tune for highest "S" meter reading
Antenna Trimmer .....	Tune for highest "S" meter reading
AVC Time Constant .....	Off
Noise Limiter Level .....	Off
Timer Switch .....	On

### SINGLE SIDE BAND RECEPTION.

For SSB reception the position of the controls nominally should be as follows:

Function Switch .....	CW-SSB
Send-Receive-Cal Switch .....	Receive
Selectivity Switch .....	3 Kcs
Sideband Switch .....	**Adjust for U or L
Vernier Tuning Control .....	*Adjust to "zero in" signal
Beat Frequency Oscillator Control .....	0
Slot Frequency Control .....	Counter clockwise
Slot Depth Control .....	Center
Cal Set Control .....	Set to vertical marker
RF (Sensitivity) Control .....	*Adjust to desired level
AF (Gain) Control .....	*Adjust to desired level
Tuning Range Switch .....	Set to desired frequency range
Main Tuning Control .....	*Tune for highest "S" meter readings
Antenna Trimmer .....	*Tune for highest "S" meter readings
AVC Time Constant .....	*Adjust to suit signal
Noise Limiter Level .....	Off
Timer Switch .....	On

\* The procedure for tuning in an SSB signal is relatively easier with this receiver than many other receivers which depend upon rotation of the BFO knob for "zeroing in". With the controls adjusted as specified above, peak the antenna trimmer for maximum output by either "S" meter or aural indication. Determine from experience the most commonly used method of sideband operation on the particular band desired. Turn sideband switch to U or L. Tune in an SSB signal using a moderate amount of RF and AF gain. SSB signals cause the "S" meter to vary rapidly from zero upward with audio modulation. Disregarding intelligibility, tune in the signal for maximum loudness. Then adjust the vernier tun-

ing for optimum intelligibility. The vernier tuning having a planetary drive system, shifts the main tuning by the small amount indicated on the front panel.

\*\* In single sideband operation the front panel identification of *Upper and Lower Sideband Selection* depends upon the number and location (above or below the received signal) of all heterodyning oscillators. The markings on the front panel ("L" and "U") must be interchanged on the 50-54 Mcs band. In the 6 meter (50-54 Mcs) band, the HF oscillator is on the low side with respect to the signal for improved stability. As a result, this reverses the position of the sideband with respect to the other double and triple conversion bands.

### CALIBRATE.

For dial calibration checking, the Send-Receive-Calibrate switch is set to the Cal position and all other controls should be set as listed under Code Signal Reception. The receiver is aligned with the Cal Set control set at the vertical marker and should be reasonably correct. The Cal Set Control is used to accurately reset the dial indicator lines if they are found to be slightly off calibration at any point on the dials where correct calibration is desired. The receiver is tuned to produce a zero beat response with the BFO at zero (0) and on any 100 Kcs multiple in the desired band. The Cal Set Control is then used to reset the dial indicator to the correct marker. If the dial calibration should be found to be beyond the range of the Cal Set Control, the HF Oscillator will require readjustment (see under Service and Re-alignment).

### NOTE

No provisions have been provided in this receiver to zero beat the 100 Kcs crystal calibrator against a frequency standard signal, such as WWV. The 100 Kcs crystal-controlled oscillator has been accurately set at the factory. This oscillator, plus the fact that a very low drift .005% crystal is employed, will insure sufficient accuracy for all practical purposes. For those who desire crystal calibrator frequency accuracy in the order of cycles, the procedure outlined on page 14 should be employed.





### BREAK-IN RELAY.

The receiver is equipped with a female chassis connector at the rear of the chassis, alongside the power cord entry bushing. Its purpose is to provide connection of a suitable relay for remote control of the receiver. As shipped from the factory the two terminals are connected across the Send-Receive-Cal Switch. For remote control operation, turn switch to send and connect relay contacts to the receptacle pins.

The usual antenna change over relay equipped with a set of normally closed contacts is suggested.

The choice of this relay will depend on the particular antenna system involved, such as whether a coax relay or one for open-wire line is employed.

In either case the extra set of contacts to control the receiver will be necessary.

### CAUTION

The receptacle pins open and close a part of the +105 volt D.C. regulated supply load; consequently, check all external wires and the relay for possible short circuits to ground.

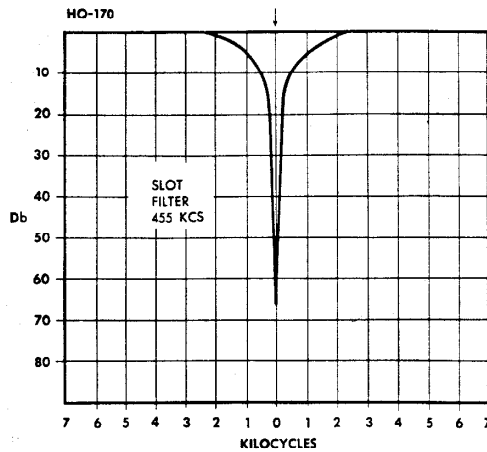

Figure 6. Slot Filter Response Curve

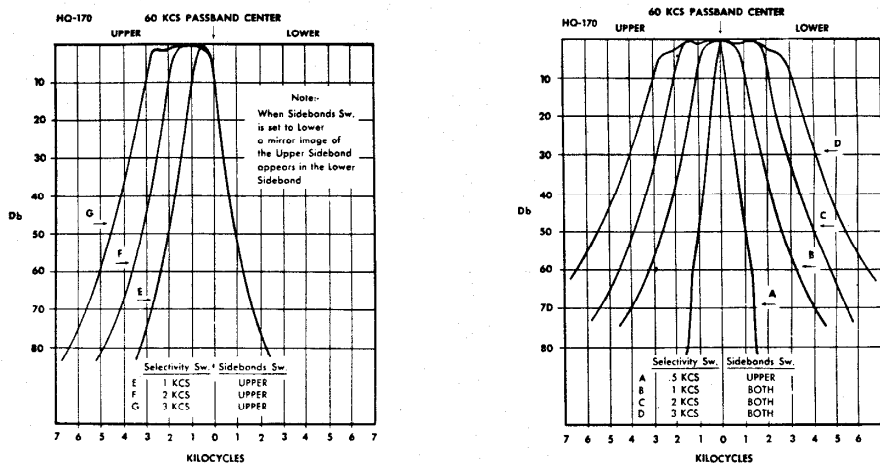

Figure 7. IF Passband Response Curves



## CIRCUIT THEORY

The HQ-170 is a triple conversion superheterodyne receiver (double conversion on the 160 and 80 meter bands) covering the 6, 10, 15, 20, 40, 80 and 160 meter amateur radio frequency bands. Seventeen tubes are used including the Rectifier and Voltage Regulator of the self-contained power supply. The circuitry of the receiver includes a 100 Kcs crystal calibrator, selectable sideband control, adjustable bandwidth (.5 to 6 Kcs) control, slot filter and depth control, adjustable AVC Decay Time constant, an effective noise limiter and a micro-accurate vernier tuning control.

### PRE-SELECTION.

The antenna input coupling and RF amplifier stage provide the necessary pre-selection and gain for high performance and rejection of undesired

signals. The high signal level at the mixer grid, V2, contributes to a favorable signal-to-noise ratio.

Both grid and plate circuits of the RF stage are tuned; individual tuning coils are selected for each band.

The antenna compensation capacitor, adjustable from the front panel, permits the receiver to be resonated for optimum performance with the particular antenna in use.

### CONVERTER STAGE.

A high degree of oscillator stability is attained by the use of a separate mixer (6BE6) V2, and an independent oscillator (6C4) V12.

The output signal from the RF amplifier V1, is heterodyned with the output of the local high

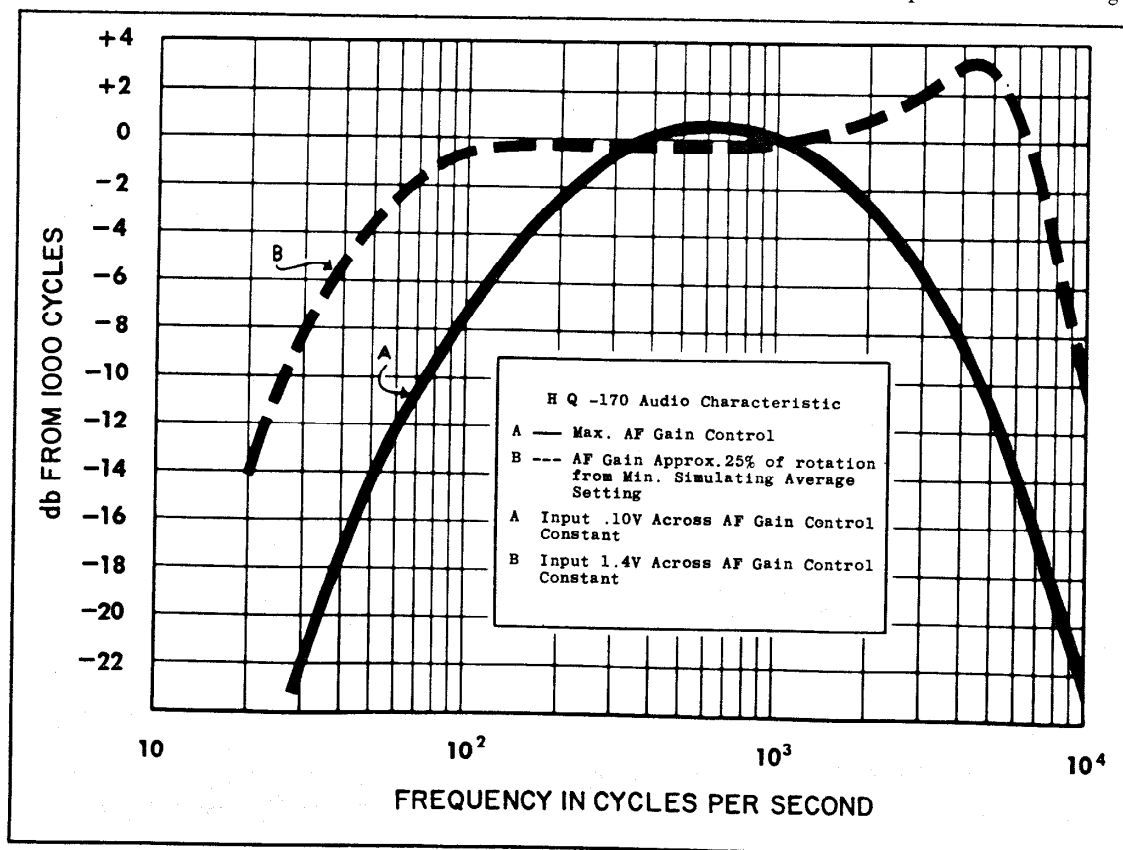

Figure 8. Auto-Response Curve



frequency oscillator V12, and electronically combined within the mixer tube V2. On the 160 (1.8-2.0 Mcs) and 80 (3.5-4.0 Mcs) meter bands, the local oscillator is located 455 Kcs above the signal frequency. On the 40 (7.0-7.3 Mcs), 20 (14-14.4 Mcs), 15 (21.0-21.6 Mcs) and 10 meter (28-30 Mcs) bands the local HF Oscillator is 3035 Kcs above the signal frequency. On the 6 meter (50-54 Mcs) band the local HF Oscillator is 3035 Kcs below the signal frequency.

When operating the 6 to 40 meter bands, the difference frequency of 3035 Kcs is heterodyned with the output of the 2580 Kcs crystal controlled oscillator and electronically combined in the converter tube V3, to produce 455 Kcs, 2nd IF. When the Band Selector switch indicates 1.8-2.0 or 3.5-4.0 Mcs bands, the crystal oscillator section of the converter tube ceases to oscillate, and the converter becomes a regular 455 Kcs IF amplifier.

Low-loss tube sockets, low-loss ceramic and phenolic, temperature compensating capacitors, and stable, coaxial glass trimmers all contribute to the oscillator's stability. Additional frequency stability is attained by applying regulated voltage to the oscillator circuit and by the rugged constructional design of the entire HF oscillator section.

#### 455 KCS IF AMPLIFIER.

The output of the second Mixer V3, is fed into a single stage 455 Kcs IF Amplifier. The gain of this stage is controlled by one section of the RF (Sensitivity) gain control.

The output circuit of this stage (V4) consists of two IF transformers, T4 and T5, which are interconnected by a means of a network of resistors, capacitors and coils comprising the Slot Filter section. This low-impedance network forms a balanced bridge arrangement known as a Bifilar "T" Trap. The slot filter inductor L3 and slot tuning capacitor C-26 form a tuned circuit which presents a very high impedance to signals passing through at the resonant frequency. Resistive balance is controlled by the Slot Depth potentiometer R26.

#### 3rd MIXER STAGE.

The third mixer stage contains its own variable oscillator. The Vernier tuning capacitor C-30 is connected across the oscillator tank circuit. High oscillator stability is achieved by using a high C to L ratio in the tank circuit and by using silver mica capacitors.

#### 60 KCS IF AMPLIFIER STAGES.

The three stage 60Kcs IF Amplifier Stages, V6, V7 and V8 following the third conversion circuit, incorporates six high-Q tuned circuits which are capacitively coupled and separately shielded. High C tuned circuits with the addition of ferrite shielding provide long time stability and freedom from external fields.

The tuned circuits are staggered in a multiplicity of combinations which are selectable by means of the selectivity and sideband switch selectors. The over-all response curves in the various positions are shown in Figure 7.

#### AVC SYSTEM.

Automatic Volume Control minimizes fading and signal strength variations by controlling the gain of the RF stage V1, 455Kcs IF stage V4, 3rd Mixer Stage V5, and the first 60Kcs IF stage V6. As a result, a comfortable and constant audio level is maintained. The fast attack (charge) and adjustable decay (SLOW-MEDIUM-FAST) can be used for the three types of signals received. The AVC voltage for the RF amplifier V1, and the 455 Kcs IF amplifier V4, is provided with a clamp type delay voltage. This prevents the AVC from operating on the first half of the receiver on extremely weak signals, thus maintaining maximum sensitivity and signal to noise ratio.

#### "S" METER (Carrier Level).

The "S" or tuning meter is provided to assist in tuning and to give an indication of relative signal strength. The "S" meter is connected in the well known highly stable balanced bridge meter circuit and utilizes the current amplification of one half section of V13 (12AU7). The input to the "S" meter circuit is connected to the separate AVC diode section of V8 (6BV8) and gives an indication of signal strength on all types of signals, and on all positions of AVC. However, the "S" meter calibration is *valid only with AVC positions SLOW-MEDIUM-FAST* and not in OFF position, although it will still indicate and may be usable in manual position.

The meter which is calibrated to 40 db over S9, is factory adjusted so that a signal input of approximately 50 microvolts gives a reading of S-9. Each "S" unit indicates a 6 db increase equivalent to doubling signal strength. Should meter re-adjustment be necessary:

1. Turn receiver off, and adjust the mechanical zero of pointer with a small bladed screw driver, if required.



2. Turn receiver on, and allow 1/2 hour warm-up.
3. Set Function Switch to receive and turn Sensitivity (RF) control counter clockwise.
4. Adjust meter zero adjust potentiometer R20 (rear of chassis) to zero.
5. Turn RF gain control to max. and feed in a 50 microvolt signal through a dummy antenna resistor. Adjust meter sensitivity potentiometer R19 for meter reading of S9. Controls set for AM reception. (See Operation Section).

#### NOTE

Usually, R19 will not require readjustment, since the factory setting will vary only slightly as a result of tube changes, ageing, etc. R19 should, therefore, be adjusted only in the event that it is desirable to make the meter more sensitive, or as part of the complete realignment procedure.

#### DETECTOR-NOISE LIMITER SYSTEM.

The double diode sections of V8 (6BV8) comprise two AM diode detector circuits; one for use with the AVC and meter system, and the other for detection of AM signals. This system produces minimum distortion.

When the Reception switch is turned to SSB/CW, the AM diode detector is disabled and the 60 Kcs IF Signal is fed into the product detector tube V9 (12AU7). Simultaneously, the BFO (1/2 section of V13) is turned on and is coupled to the product detector, V9 (pin 7).

The best means of detection of SSB signals is with the double-triode product detector circuit. It

recovers the intelligence from the RF signal with the least amount of distortion under large variation of input signal strength.

Tube V10 (6AL5) functions as a positive and negative noise pulse-clipping limiter and is also usable as a squelch for AM signals.

#### BEAT FREQUENCY OSCILLATOR.

The Beat Frequency Oscillator control C129 varies the tuning of the 60 Kcs Beat Frequency Oscillator (1/2 of 12AU7-V13) over a range from zero beat to plus or minus 2 Kcs. The BFO is connected in the well-known high stability Clapp circuit.

#### AUDIO AMPLIFIER.

The first audio stage V16 (6AV6) is a resistance coupled voltage amplifier. The audio output stage V17 (6AQ5) is a beam power amplifier, providing an undistorted output of at least one watt.

A feature of the audio system is the variable negative feedback employed (see Auto Response Curve, Figure 8). Maximum feedback is provided at low settings of the Audio Gain control for fine quality reception of strong stations.

As the Audio Gain control is increased, the feedback decreases so that on reception of weak signals additional sensitivity is provided by the audio section. This results in an increased signal to noise ratio. A further advantage is the critical damping of the speaker for elimination of speaker "hangover". This upgrades the reception of speech and music and decreases the noise output of the receiver. Still another advantage is the reduction of distortion at the lower settings of the Audio Gain Control.

#### MEMORANDA

##### SINGLE SIDEBAND

IN ORDER TO OBTAIN OPTIMUM RECEPTION OF SSB AND ALLOW PROPER SIDEBAND SWITCHING, THE B.F.O. FREQUENCY MUST BE ACCURATELY ZEROED TO THE CENTER OF THE IF PASSBAND.

THIS CAN BE DONE IN THE FOLLOWING MANNER:

SET THE SIDEBAND SELECTOR ON LOWER; SELECTIVITY SWITCH ON .5KCS; FUNCTION SWITCH ON AM; AND THE SEND/REC/CAL SWITCH ON CAL. CAREFULLY TUNE IN THE CRYSTAL CALIBRATOR SIGNAL, PREFERABLY ON THE 160 METER BAND. FOR A PEAK S METER READING, NOW PLACE THE FUNCTION SWITCH ON CW/SSB AND SLOWLY ADJUST THE B.F.O. CONTROL FOR ZERO BEAT WITH THE INCOMING SIGNAL. THE SIDEBAND AND SELECTIVITY CONTROLS CAN NOW BE RETURNED TO THEIR NORMAL POSITIONS.

ONCE THE B.F.O. HAS BEEN PROPERLY SET IN THE ABOVE MANNER, IT WILL REQUIRE NO FURTHER ADJUSTMENT FOR SSB OPERATION. ALL SIDEBAND SWITCHING CAN BE ACCOMPLISHED WITH THE APPROPRIATE CONTROL. FAILURE TO OBSERVE THIS PRECAUTION WILL RESULT IN ONE SIDEBAND BEING FAVORED AND DEGRADED SSB PERFORMANCE.



## SERVICE AND ALIGNMENT PROCEDURE

### NOTE

Before servicing this receiver, disconnect from the power source and remove all lead wires attached to terminal connections located at the rear of the chassis apron. Carefully turn the receiver onto its front panel face on a smooth clean surface (preferably a soft cloth). Remove the three No. 10 hex head machine screws which fasten the chassis to the cabinet. Remove the knob from the clock adjustment shaft if the receiver is so equipped. Lift the cabinet straight up and off the

chassis. To re-assemble, reverse this procedure.

### IF ALIGNMENT.

### NOTE

Two non-metallic alignment tools are required for complete alignment: General Cement Co. No. 5097, or equal. General Cement Co. No. 8282, or equal. Unless otherwise specified, all front panel controls shall be positioned as follows for the complete alignment of the receiver:

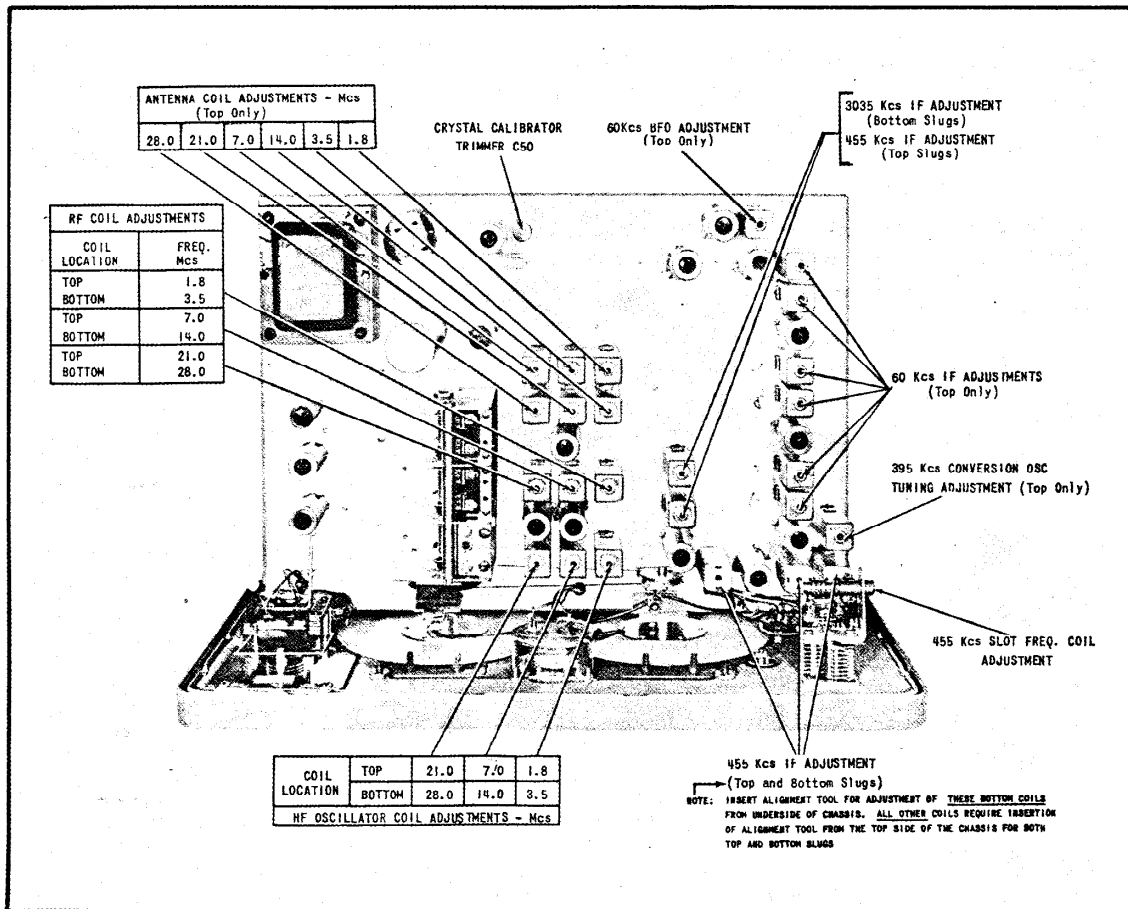

Figure 9. Top View of Chassis



KNOB FUNCTION	NOMINAL POSITION
Band Selector .....	14-14.4 mcs band
Pass Band Tuning Dial .....	0
AM-SSB/CW Selector .....	AM
Side Band Selector .....	Both
Selectivity Selector .....	3 Kcs
Slot Frequency .....	Counter-clockwise
Slot depth .....	Counter-clockwise
Beat Frequency Oscillator .....	0
Noise Limiter .....	Off
AVC .....	Off
Antenna .....	Center
Calibration Reset .....	Center
Send-Receive Switch .....	Receive
Audio & RF Gain .....	Adjust to Test Requirements

### NOTE

The receiver should be warmed up for a period of at least 1/2 hour before proceeding with the complete alignment.

Connect the output cable of a 60 Kcs unmodulated signal generator known to be accurate, to the grid (pin 7) of third mixer V5 and the chassis. Connect a dc vacuum tube voltmeter between the grid (pin 2) of V13 (meter amplifier) and the chassis. Turn the selectivity switch to 0.5 Kc and the sideband switch to "L". Peak transformers T6, T7, T8, T9, T10 and T11 for maximum negative D-C volts. Always keep output volts in the vicinity of -5 volts D.C.

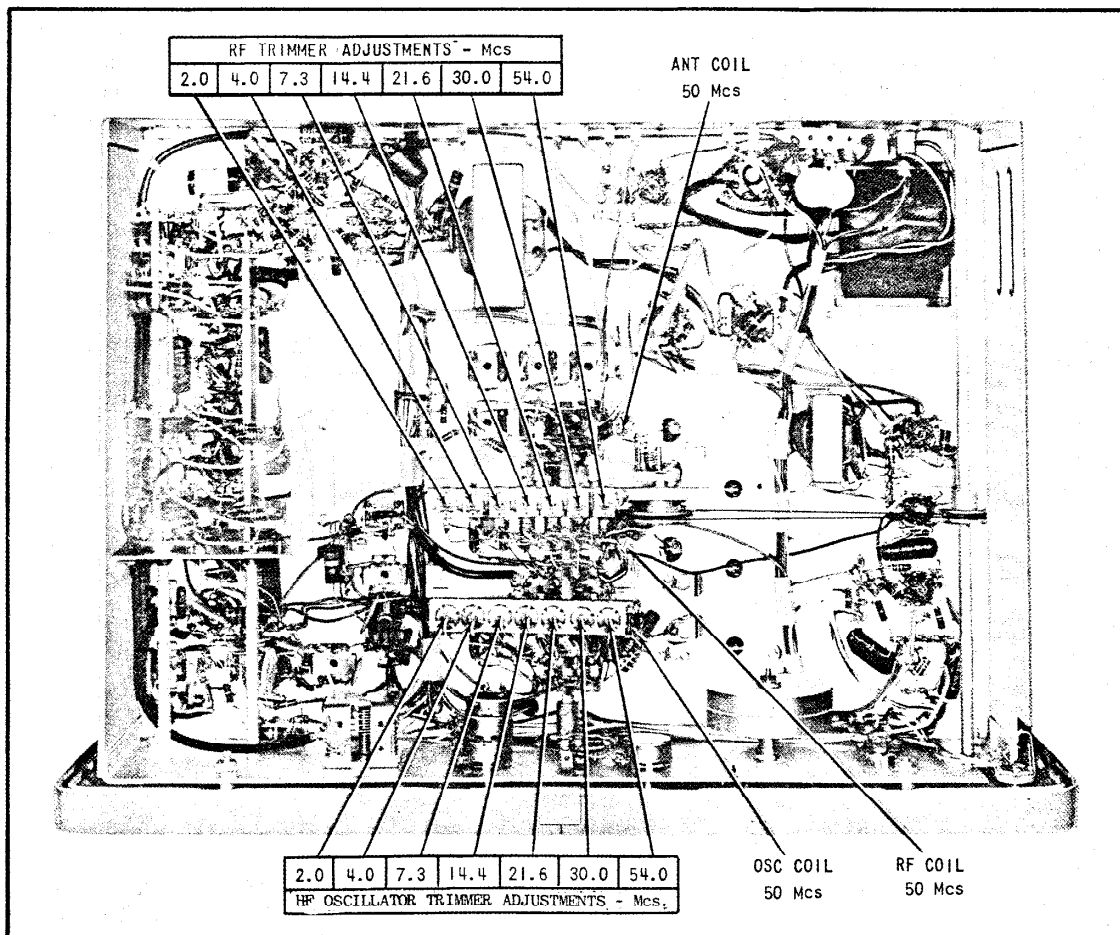

Figure 10. Bottom View of Chassis



Turn the Function Switch to SSB/CW and with the "BFO KCS" control set at zero, adjust the BFO Transformer T28 for zero beat heard in the loudspeaker, then return switch to AM.

Reduce Signal Generator output to zero and adjust the "S" meter zero position by means of the screw-driver slotted control R20 which is located on the rear apron of the chassis. Remove the generator lead.

Connect the output cable of an accurately known 455 Kcs unmodulated signal generator to the grid (pin 7) of the first mixer V2 (6BE6) and the chassis. Turn the Band Selector to 3.5-4.0 Mcs band. Peak the passband tuning transformer L4 for maximum output (topside adjustment most convenient). Then, peak the top and bottom cores of IF transformers T3, T4 and T5 and the top cores of IF transformers T1 and T2.

Turn Slot Frequency control to "O" and Slot Depth control to mid-position and adjust slot filter coil L2, located directly behind slot frequency control, for minimum meter reading. Raise the input signal to obtain sufficient meter deflection. Return these controls to nominal positions.

Turn the band selector to the 14.0-14.4 Mcs band and feed in a 3035Kcs unmodulated signal. Adjust the generator frequency for maximum output, then peak the bottom cores of Transformers T1 and T2 for maximum output.

Turn Selectivity switch to 3 Kcs position and sideband selector to the "BOTH" sideband position.

## RF ALIGNMENT.

### NOTE

Alignment tool such as General Cement Co. 8282 or equal is required.

a. The cores and trimmers have been factory adjusted, and should require only a minimum amount of readjustment for any realignment.

b. All RF and oscillator core adjustments are made from the top of the shield cans with exception of the 50-54 Mcs coils. The 50-54 Mcs RF coil is adjusted from the underside of the chassis by varying the turn spacing. A slight spreading of the turns decreases the inductance and, conversely, pushing the turns slightly closer together increases the inductance. The 50-54 Mcs Antenna coil, as a rule, will not require readjustments because of the large range of adjustment of the antenna trimmer capacitor. Before proceeding with

the actual alignment, check cord drive and knob orientation of the antenna tuning drive system. The antenna capacitor should be half open when the Knob marking is vertical (see Figure 12).

c. Connect the unmodulated, signal generator output cable to the antenna and ground terminals of the receiver, with both links on the antenna terminal strip closed.

d. Set the controls the same as for IF alignment. Connect a d-c vacuum tube voltmeter between the grid (pin 7) of meter amplifier V13 and the chassis. Always keep output volts in the vicinity of -5 volts D.C. Adjust the sensitivity control as required to obtain a sufficient voltmeter reading and to prevent overloading. Adjust Calibration Reset Knob for alignment between window and escutcheon markings.

e. The oscillator adjustments are performed first. The RF is adjusted next to obtain maximum amplitude. The antenna cores are adjusted last. A certain amount of inter-action will occur between the oscillator and RF adjustments, particularly on the higher frequency bands. Final adjustment should be accomplished by combined or alternate adjustment of the oscillator and RF for maximum amplitude.

### NOTE

The trimmer adjustments, if required, should be final adjustments for each band.

f. Note that the oscillator frequency of the HQ-170 is on the high side of the signal frequency, except on the 50-54 Mcs band where it is on the low side. Therefore, it is necessary to make sure that the oscillator frequency is not adjusted below the signal frequency which would be an image response of the signal on all bands, except 50-54 Mcs where the reverse is true.

g. On the 50-54 Mcs band, a shift in oscillator frequency occurs upon replacing the receiver in the cabinet, with the result that the dial calibration reads approximately 50 Kcs, or one division low. This condition may be remedied as follows:

(1) After alignment in the usual manner with the receiver out of the cabinet, adjust the 50-54 Mcs oscillator coil T26 until a 50.00 Mcs signal is received at approximately 50.05 Mcs on the dial.

(2) Place the chassis in the cabinet or place a metal plate (such as a cookie sheet) over the bottom of the chassis. The dial reading should be



approximately correct. If it is not, another re-adjustment of the oscillator coil T26 is required.

#### CALIBRATOR ALIGNMENT:

The crystal calibrator is factory adjusted to zero beat with the National Bureau of Standards Radio Signal emanating from WWV. If minor adjustment is determined to be necessary to re-zero the calibrator, an external receiver capable of receiving signals from Radio Station WWV on any one of its operating frequencies is necessary since the tuning bands of the HQ-170 receiver do not include any of these frequencies.

To re-zero the calibrator, loop one or two turns of insulated wire around the envelope of V11 (6BZ6-Crystal Calibrator) and connect the wire to the antenna terminal of the receiver used for heterodyning. Tune in a strong signal on any one of the WWV frequencies and zero-beat the calibrating oscillator with WWV by slowly rotating the ceramic trimmer C50 at the top rear of the chassis.

For a quick check of the 100 Kcs calibrator setting without having to remove the cabinet from the HQ-170, connect the antenna terminal of the receiver being tuned to WWV, to the antenna terminal of the HQ-170 that is farthest away from the ground terminal.

### Dial Cable Assembly

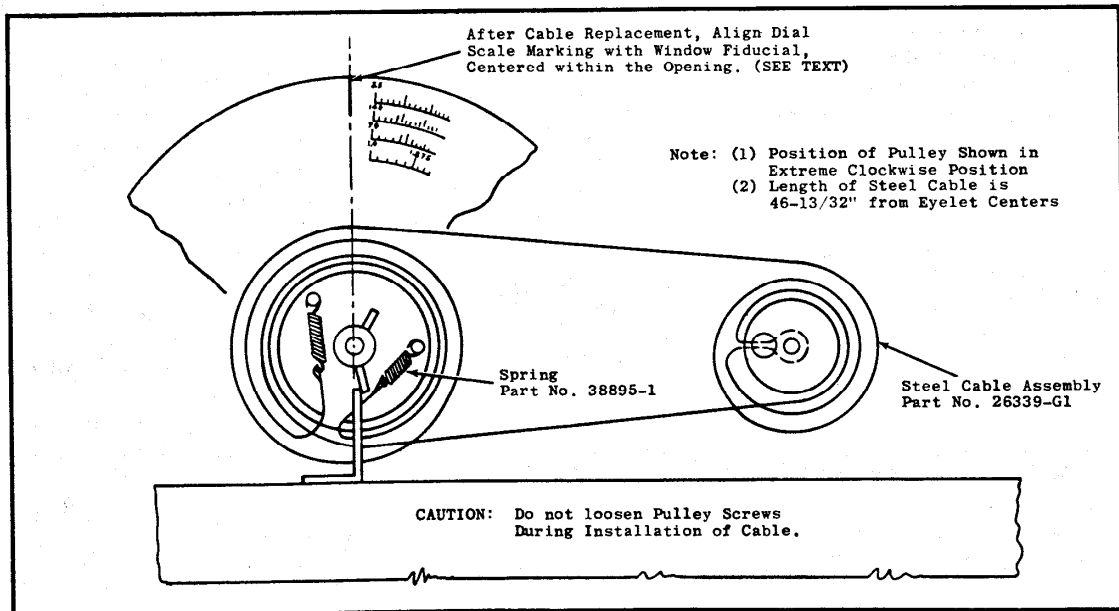

Figure 11. Installation of Dial Cable Assembly





## MAINTENANCE

The HQ-170 is designed to give years of trouble-free service. Tube failure is the most common source of trouble. The second most common cause of difficulty is component failure among small resistors and fixed capacitors.

The following charts give voltages and resistances between tube socket terminals and chassis. Voltages indicated are those measured with a vacuum tube voltmeter; resistances with a vacuum tube ohmmeter. Slight variations in the order of 10 per cent from indicated values should be disregarded.

With the aid of the chart and schematic diagram, components can usually be located. The parts listing in the back pages of this manual gives component values and Hammarlund part numbers.

Standard items may be purchased locally, non-standard components are available on order from the factory.

A sensitive communications receiver should be entrusted only to a qualified technician. Should difficulty be experienced, please write Hammarlund Manufacturing Company for advice or to arrange for factory service.

### Instructions for Replacement of Dial Cable Assembly

#### DIS-ASSEMBLY.

1. Disconnect power plug from the AC power source and place the receiver along the edge of a work table so that the front panel overhangs the edge of the table.
2. Remove all knobs, screws, nuts and pointers from the controls fastened to the front panel (including clock). Remove nut and lockwasher from window friction drive assembly. Note position of each piece while taking the unit apart.
3. Unsolder the "S" meter wires only and remove pilot light from "S" meter. Note color coding and polarity of leads for ease of re-assembly.
4. Remove the three (3) oval head screws with spacers which fasten the panel to the chassis and slide the panel gently away from the chassis.
- 5a. Remove the nut and lockwasher on the main tuning friction drive assembly, and carefully observe the location of each piece while disassembling the unit.
- 5b. Unhook the small "U" shaped clips which fasten the window assembly to dial scale collars.
- 5c. Remove the dial scale mounted on the tuning capacitor shaft by loosening the set screws on the dial scale collar.

#### ASSEMBLY.

1. Fold the dial cable in half, and insert the bent-loop end into the small hole of smaller pulley and loop the dial cable around the shaft (see figure 11).
2. Wrap one half of the dial cable around the smaller pulley for  $\frac{3}{4}$  of a turn in a clockwise direction. Guide this half of the cable underneath the larger pulley and wrap around the large pulley one (1) complete turn clockwise then hook the spring to the hole on the right side (see figure 11).
3. Wrap the other half of the cable  $1\frac{3}{4}$  turns counter-clockwise and guide this end to the larger pulley. Loop larger pulley  $1\frac{1}{2}$  turns in counter-clockwise direction and fasten spring hook to the left pulley hole.
4. Turn both pulleys by hand back and forth, and manipulate until the tension on both springs is approximately equal.
- 5a. Replace the dial scale and moderately tighten the set screws after the scale has been aligned. Adjust before tightening so that the plastic surfaces are in line and the left ends of both dial scales are parallel.
- 5b. Replace the Friction Drive Assembly.
- 5c. Fasten the "window" assembly to the dial drive assemblies by means of the "U" shaped clips.



6. Fasten the Front Panel Assembly to the chassis by means of the (3) oval headed screws, spacers, and nuts.
7. Fasten the front panel controls to the front panel including fiducial drive assembly. Fasten all knobs and pointers to their proper controls. Adjust knob markings to match panel markings.
8. Adjust fiducial markings to center of window cutouts. Turn main tuning knob until tuning capacitor plates are fully meshed. Check this adjustment very carefully with the end of a strip of metal such as a 6 inch steel rule. The extreme upper edges of the rotor plates must be "in line" with the edges of the adjacent stator plates. After this careful adjustment is made, loosen the set screws on the tuning capacitor dial scale and gently turn the main tuning knob (while restraining the capacitor plates from turning) until the indexing line on the left dial scale (line is located  $\frac{1}{4}$ " away from low frequency end of dial scale) is directly behind the fiducial line. Tighten the set screws. Re-check and readjust, if necessary.
9. Turn main tuning knob to indicate the low frequency end of band on the left dial. Then loosen set screws which fasten the right dial scale to its shaft and adjust right dial so that its low frequency end markings *match* the low frequency end dial markings on the left dial scale.
10. Re-align the entire R.F. section as outlined in the paragraph under RF Alignment Procedure.

## Instructions for Replacement of Antenna Trimmer Cord Assembly

See figure 12 below.

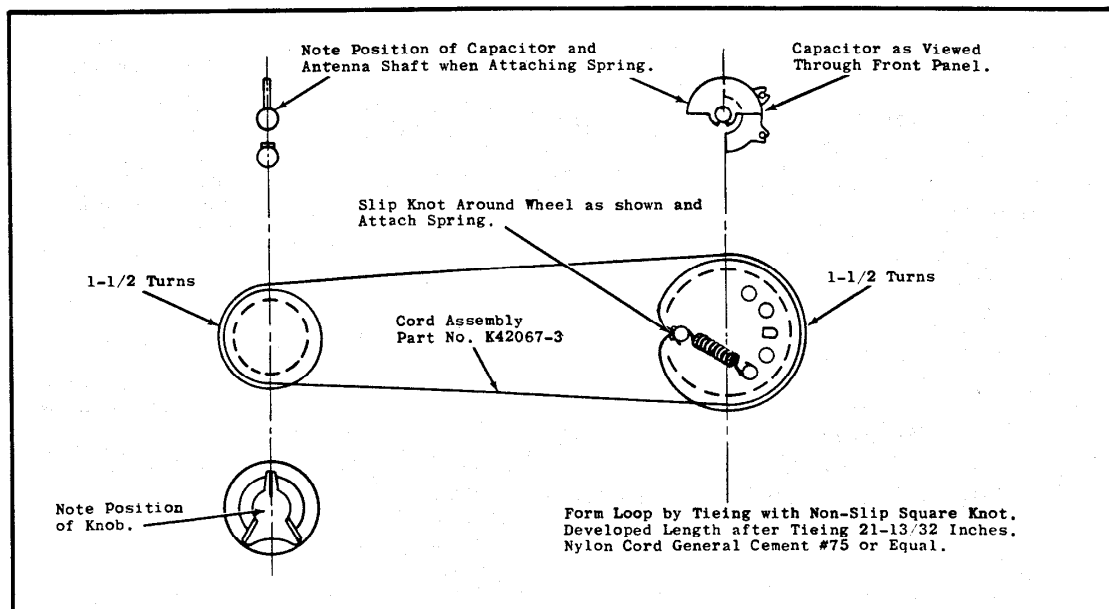

Figure 12. Installation of Antenna Trimmer Cord Assembly



## INSTALLATION AND OPERATING SUGGESTIONS

### 1. .5 Kc SELECTIVITY POSITION

Whenever the 500 cycle or .5 kc *Selectivity* switch position is employed, for best results the side band switch should be employed in the upper side band position. Since this band width is only employed and usable on CW, the BFO pitch or frequency control should always be employed plus or minus approximately .5 kc for best CW performance.

The headphone jack results in a deliberate mismatch to high impedance phones, in order to reduce the level supplied to them. The lower the impedance of the phones, the more volume will usually be obtained. If it is desirable to increase the headphone volume, an inexpensive line to voice coil transformer is suggested. This transformer is connected backwards with the voice coil connections to headphone plug and the 500 Ohm line connections to the phones. The resultant impedance step up will provide higher headphone volume. This procedure should only be resorted to when absolutely necessary such as when a person may be hard of hearing. It should be remembered that as a result of increasing the headphone level any residual hum will also be increased, which the hard of hearing person will not find objectionable, whereas a person with normal hearing may.

### 2. VOX CIRCUIT REQUIREMENTS

In the event that the vox circuit in your transmitter may be designed for 500 Ohm input and that sufficient gain in this circuit may not be available to provide proper performance from the 3.2 voice coil winding, the matching transformer referred to in the headphone paragraph may be employed. Under these circumstances, the voice coil winding should be connected to the speaker terminals with the 500 Ohm line winding to the vox circuit. Such a matching transformer may also be required or useful for phone patch operation, depending, of course, on the design of the phone patch.

### 3. GRID BLOCK BIASING FOR VOX CIRCUITS

Many of the single side band transmitters being produced today provide 100 volts negative bias vox which is switched from the transmitter to the receiver by the vox circuit. The Hallcraft HT 32 transmitter is a good example. As a result of the voice control operating the relay in the transmitter, the 100 volts negative bias available in the transmitter is

made available to silence the receiver. When this type of receiver silencing is desired the relay receptacle on the rear of the HQ-170 is not employed. In order to adapt your HQ-170 for this operation it is suggested that the two leads that are now connected to the relay receptacle be removed and each one taped up so that they are insulated from one another and the chassis. These may be dressed conveniently out of the way. A 5 megohm  $\frac{1}{2}$  watt resistor and 15" of insulated shielded lead is now required. One end of the 5 megohm resistor should be connected to pins 5 or 6 tube socket V16 (6AV6). The other end of this resistor is then connected to the inner conductor of the insulated shielded lead with the shield left floating at this point and insulated to prevent its shorting to the resistor, inner conductor, or any part of the wiring. The other end of this insulated shielded lead should have the center conductor connected to one or both of the relay terminals with the shield connected to any convenient ground or chassis connection. The 100 volt negative bias lead from the vox circuit is then connected to one or both of the relay receptacle terminals, a standard AC plug may be employed in the relay receptacle. It is now necessary to employ a common ground connection between the HQ-170 chassis and the transmitter chassis in order to complete the biasing circuit. Making these changes will result in the 5 megohm resistor being in series with the bias lead to the AVC bus in the HQ-170. The 5 megohm resistor isolates the bias supply and prevents this lead from affecting the AVC circuit. The shielded lead is recommended to prevent RF pickup and is really a precautionary measure. It may also be advisable to employ a shielded lead between the receiver and transmitter.

### WARNING

This system in no way implies that the antenna changeover relay or a suitable TR switch will not be required. Failure to employ one or the other may result in burning out the antenna coils of the receiver, or other possible damage.

Tests indicate that minus 75 volts will silence the receiver when one volt of RF is applied to the antenna terminals. 75 volts negative bias is therefore, the suggested minimum value for complete silencing. The full bias voltage is not applied to the grids due to a voltage division which takes place as a result of the 5 megohm resistor and the other resistors employed in the AVC system.



#### 4. DIAL CALIBRATION ACCURACY

Please remember that we do not claim frequency meter accuracy. Our production tolerance on this receiver is plus or minus  $\frac{1}{2}$  a dial division. This tolerance is necessary as a result of working to printed dial scales. The band edge markers are held to very close tolerance, usually plus or minus the thickness of the dialmarker. The total runout or what is often referred to as tracking error, will usually be within the plus or minus  $\frac{1}{2}$  a dial division as previously specified. It is for this reason that the adjustable dial marker and the 100 kc calibrator are provided for the correction factors.

#### 5. RF FEED BACK

In the event that RF feed back is experienced when the relay terminals on the rear of the HQ-170 are employed, this usually indicates that the relay leads between the receiver and antenna relay are picking up RF. This may be due to the particular lead length or a high standing wave ratio on the antenna system. The solution is of course, to prevent the RF pickup of the relay leads from getting into the receiver. Adding a pair of .01 disc ceramic capacitors from each of the relay terminals to ground will usually eliminate the feed back condition. These extra .01 capacitors should be installed using as short lead length as possible, and preferably mounted.

#### 6. SLOT DEPTH CONTROL

The slot depth control is actually a very gradual vernier adjustment. In view of this its effect will not be very noticeable unless the

proper procedure is employed. The suggested procedure is as follows:

Tune in an AM signal on any band or any other strong constant carrier of similar nature, such as crystal calibrator. Whenever the receiver is being tuned for normal reception be sure to first rotate the slot frequency control to the extreme clockwise or counter clockwise position. In other words, never leave the slot frequency control at or near the zero setting. If this procedure is not followed it is obvious that the center of the pass band will be slotted out, in some cases this being quite obvious by producing 2 spot tuning or 2 peak S meter readings.

After tuning in the constant carrier and peaking the S meter, taking the above precautions, rotate the slot frequency control. It will be noticed that upon approaching the zero setting, the S meter reading will be effected. A very definite null or minimum S meter reading will be obtained with the slot frequency control adjusted at or near zero. Observe this S meter reading. With the slot frequency control set at the minimum S meter reading position, the slot depth control should be rotated very slowly throughout its range, observing the S meter. It will be found that one particular spot throughout the range of the slot depth control a further reduction in the S meter reading will be obtained. Once this setting has been obtained, the slot depth control may be left permanently in this position, and all future slot filter adjustment made by the slot frequency control only. A check of the slot depth control setting may be advisable periodically.

## TELECHRON AUTOMATIC TIMER

If your receiver is equipped with the built-in Telechron Automatic Clock-Timer, the following instructions should be noted:

Every radio-frequency device is stable only at pre-determined operating temperatures. In order to eliminate waiting for the receiver to warm-up to operating temperature, the Telechron Timer automatically turns on the receiver ahead of anticipated operating time. This is accomplished by setting the hand of the timer (small knob at the rear of the receiver) to approximately one-half hour before operating time. The front panel control under the Clock-Timer is then set to "Auto" position. The function switch is set to "Rec" and the R.F. gain is advanced to power "on". The receiver is then automatically turned on at the desired (preset) time. If the function switch is set to "Send" instead of "Rec", the Receiver will automatically be turned on and will be in the standby position.

The clock hands are set by the rear knob. "Push-in" and turn the knob to set the switch timing hand; and "Pull-out" and turn the knob to set the clock hands. The front switch is set to "Auto" only when it is desired to use the automatic clock switch for pre-warming the receiver before operation or for use as an alarm to turn the receiver on to a pre-tuned station. To use the function switch normally, the clock switch should be left in the "ON" position.

The clock will continue to run as long as the receiver line cord is connected to the power outlet, and is extremely useful for checking sign-in periods and schedules.

If your receiver is not equipped with the Telechron Automatic Clock-Timer, and you would care to have the accessory added, the Clock Kit with full instructions may be purchased from your local Hammarlund dealer. (See Parts List for Part Number).

TABLE 1. TUBE SOCKET VOLTAGES

Unless otherwise specified, Band 14.0 - 14.4 Mc; AVC - OFF; Noise Limiter - OFF; Function Switch (Type of Reception) - AM; RF Sensitivity Control - max; AF Gain Control - min; Antenna - disconnected; SIDE BANDS - BOTH; SELECT KCS - 3 Kc; Function Switch - (SEND - RECEIVE - CAL.) - RECEIVE. AC Line Voltage - 117 volts. 120 watts.

TUBE	SOCKET PIN NUMBERS																
	1	2	3	4	5	6	7	8	9	10	11	12	13	14	15	16	17
V1 RF Tube 6BZ6	- 65	R.F. Gain 1.35 (max) 4.0 (min)	0	6.3 AC	105	250	0	--	--								
V2 1st Mixer 6BE6	-3.8	1.65	0	6.3 AC	250	105	0	--	--								
V3 2nd Mixer 6BE6	-4.0	0	6.3 AC	0	248	98	0	--	--								
V4 2nd IF 6BA6	- .67	0	0	6.3 AC	245	100	R.F. gain 1.9 (max) 23 (min)	--	--								
V5 3rd Mixer 6BE6	-6.8	0	0	6.3 AC	247	77	-.56	--	--								
V6 3rd IF (1) 6BA6	-.56	0	0	6.3 AC	235	100	.86	--	--								
V7 3rd IF (2) 6BA6	0	0	0	6.3 AC	230	90	.90	--	--								
V8 3rd IF (3) DET-AVC 6BV8	5.2	0	240	0	6.3 AC	-.56	0	0	-.7								
V9 Prod. Det. 12AU7	225(SSB)	0	7.8(SSB)	6.3 AC	6.3 AC	110 (SSB)	0	7.8(SSB)	0								
V10 Noise Lim 6AL5	40 (off) 1.1 (max)	40 (off) 0 (max)	0	6.3 AC	40 (off) 1.1 (max)	0	40 (off) 0 (max)	--	--								
V11 Calibrator 6HZ6	-10 to -25 (cal on)	4 to 8 (cal on)	6.3 AC	0	25 to 40 (cal on)	6 to 8	4 to 8 (cal on)	--	--								
V12 H.F. Osc. 6C4	100	--	0	6.3 AC	--	-4.8	0	--	--								
V13 BFO-Meter 12AU7	105	-.56	4.0	6.3 AC	6.3 AC	225 (SSB)	135	140	0								
V14 Volt. Reg. 0B2	105	--	Tie Point 5.7	--	105	--	--	--	--								
V15 Rect. 5U4GB	Tie Point 6.3 AC	280	--	245 AC	--	245 AC	Tie Point AC Line	280	--								
V16 1st Audio- AVC 6AV6	-.95	0	6.3 AC	0	-.68	-.68	80	--	--								
V17 Pwr. Ampl. 6AQ5	0	15	6.3 AC	0	270	250	--	--	--								





TABLE 2. TUBE SOCKET RESISTANCES

Conditions are the same as in the voltage chart unless otherwise specified.

TUBE	SOCKET PIN NUMBERS								
	1	2	3	4	5	6	7	8	9
V1 RF 6BZ6	3M	180 1.7k(min) (gain)	0	--	17K	15K	0	--	--
V2 Mixer 6BE6	22K	160	0	--	18K	15K	0	--	--
V3 Mixer 6BE6	22K	0	--	0	16K	19K	0	--	--
V4 IF 6BA6	2.5M	0	0	--	17K	15K	180 10K(min gain)	--	--
V5 Mixer 6BE6	22K	8	0	--	18K	42K	2.5M	--	--
V6 IF 6BA6	3.0M	0	0	--	19.5K	66K	68	--	--
V7 IF 6BA6	470K	0	0	--	19.5K	66K	68	--	--
V8 IF-DET 6BV8	560	18.5	18K	--	0	51K	70	0	51K
V9 PROD DET 12AU7	INF 17K(SSE)	470K	820	--	--	55K	100K	820	0
V10 Noise Lim. 6AL5	220K	1.25M	0	--	220K	0	1.5M	--	--
V11 Cal 6BZ6	470K	47K	--	0	INF 500 (cal on)	INF 50K (cal on)	47K	--	--
V12 Osc 6C4	15K	--	0	--	--	47K	0	--	--
V13 BFO 12AU7	15K	47K	900	--	--	INF 17K(on)	500K	47K	0
V14 Reg OB2	15K	--	--	--	15K	--	0	--	--
V15 Rect 5U4GB	FIL Tie Point	17K	--	28	--	28	AC Line Tie Point	17K	--
V16 Audio 6AV6	4.7M	0	--	0	2.4M	2.4M	470K	--	--
V17 Ampl 6AQ5	470K	430	--	0	17K	17K	--	--	--



## PARTS LIST HQ-170

SCHEMATIC DESIGNATION	DESCRIPTION	HAMMARLUND PART NO.
<b>CAPACITORS</b>		
C1, A-F	Variable, Tuning	P38901-1
C2, C4, C5, C6, C7, C9	Fixed, ceramic disc, .01 mf 600 W.V.D.C.	K23034-19
C10, C11, C15, C17		
C18, C21, C23, C32,		
C39, C41, C47, C81		
C124, C130, C133, C141		
C3, C8	Fixed, ceramic disc, 110 mmf 1000 W.V.D.C.	K23010-5
C12, C33, C36, C38	Fixed, ceramic disc, .02 mf 600 W.V.D.C.	K23034-9
C40, C46, C136, C137		
C13, C89, C97, C111	Fixed, silver mica, 20 mmf 500 W.V.D.C.	K23006-17
C113, C120, C123		
C14	Fixed, silver mica, 560 mmf 500 W.V.D.C.	K23027-6
C16	Fixed, silver mica, 3.0 mmf 500 W.V.D.C.	K23006-18
C19, C20	Fixed, ceramic disc, .04 mf 600 W.V.D.C.	M23034-12
C22, C27	Fixed, ceramic disc, .01 mf 1000 W.V.D.C.	K23034-25
C24	Fixed, silver mica, 1200 mmf 500 W.V.D.C.	K23027-4
C25	Fixed, mylar, .033 mf 200 W.V.D.C.	K23044-1
C26	Variable, slot freq.	K42041-1
C28, C79, C104, C110	Fixed, silver mica, 7 mmf 500 W.V.D.C.	K23006-24
C115, C117, C122		
C29	Fixed, silver mica, 780 mmf 300 W.V.D.C.	K23006-39
C30	Variable, vernier tuning	K42040-2
C31, C51	Fixed, silver mica, 100 mmf 500 W.V.D.C.	K23006-1
C34, C37	Fixed, silver mica, 24 mmf 500 W.V.D.C.	K23006-7
C35	Fixed, Temp. Comp, 330 mmf 500 W.V.D.C.	K23010-9
C42	Fixed, ceramic disc, 500 mmf 1000 W.V.D.C.	M23034-13
C43, C60	Fixed, silver mica, 10 mmf 500 W.V.D.C.	K23006-8
C44, C45	Fixed, ceramic disc, 2000 mmf 1000 W.V.D.C.	M23034-18
C48, C87, C128	Fixed, paper, .1 mf 200 W.V.D.C.	K23045-3
C49, C95, C105	Fixed, paper, .047 mf 400 W.V.D.C.	K23045-2
C50	Variable, Calibrator 8-50 mmf	K23038-5
C52	Variable Antenna Comp.	K34454-G14
C53, C54	Variable mica trimmer, 3-35 mmf	K23043-5
C55, C56, C57, C58,	Variable, mica trimmer, 1.5-20 mmf	K23043-6
C59		
C61, C140	Fixed, silver mica, 25 mmf 500 W.V.D.C.	K23006-41
C62, C63, C68, C70,	Variable, rotary trimmer 1-8 mmf	K23008-1
C74		
C64, C65	Variable, rotary trimmer 1.5-9.1 mmf	K23057-1
C66	Fixed, Temp. Comp, 4.7 mmf 1000 W.V.D.C.	K23058-222C
C67	Fixed, silver mica, 68 mmf 500 W.V.D.C.	K23006-30
C69	Fixed, silver mica, 83 mmf 500 W.V.D.C.	K23006-29
C71	Fixed, silver mica, 243 mmf 500 W.V.D.C.	K23006-27
C72	Fixed, Temp. Comp, 8.0 mmf 1000 W.V.D.C.	K23061-206D
C73	Fixed, Temp. Comp, 12 mmf 1000 W.V.D.C.	K23010-19
C75	Fixed, silver mica, 10 mmf 500 W.V.D.C.	K23006-8
C76	Fixed, Temp. Comp, 20 mmf 1000 W.V.D.C.	K23061-17J
C77, C78	Fixed, silver mica, 47 mmf	K23006-47
C143, C144	300 W.V.D.C.	
C80	Fixed, Temp. Comp, 4.7 mmf 500 W.V.D.C.	K23010-8
C82, a, b, c, d	Fixed, Electrolytic, 60, 40, 40, 40 mf	K15504-71
C83, C84	Fixed, ceramic disc, .01 mf 1400 W.V.D.C.	M23034-26
C85	Fixed, paper, .1 mf 600 W.V.D.C.	K23045-5
C86, C94	Fixed, silver mica, 31 mmf 500 W.V.D.C.	K23006-15
C87	Fixed, paper, .1 mf 200 W.V.D.C.	K23045-3
C88, C90, C96, C98	Fixed, silver mica, 29 mmf 500 W.V.D.C.	K23006-16
C91, C99	Fixed, silver mica, 28 mmf 500 W.V.D.C.	K23006-19
C92, C100	Fixed, silver mica, 27 mmf 500 W.V.D.C.	K23006-20
C93, C101, C103, C114	Fixed, silver mica, 3.0 mmf 500 W.V.D.C.	K23006-18
C102, C109, C118	Fixed, silver mica, 9 mmf 500 W.V.D.C.	K23006-21
C106	Fixed, silver mica, 10 mmf 500 W.V.D.C.	K23006-22
C107, C116	Fixed, silver mica, 14 mmf 500 W.V.D.C.	K23006-25
C108, C119	Fixed, silver mica, 21 mmf 500 W.V.D.C.	K23006-26
C112, C121	Fixed, silver mica, 16 mmf 500 W.V.D.C.	K23006-23
C125	Fixed, silver mica, 47 mmf 500 W.V.D.C.	K23006-6
C126, C127	Fixed, mylar, .01 mf 400 W.V.D.C.	K23044-2
C129	Variable, BFO	K42042-1
C131	Fixed, paper, .25 mf 200 W.V.D.C.	K23045-4
C132	Fixed, ceramic disc, 5000 mmf 1000 W.V.D.C.	M23034-10
C134	Fixed, silver mica, 2 mmf 500 W.V.D.C.	K23006-37
C135	Fixed, ceramic disc, 8 mmf 1000 W.V.D.C.	M23034-11
C138	Fixed, Temp. Comp, 47 mmf 500 W.V.D.C.	K23006-26J
C139, C142	Fixed, Temp. Comp, 12 mmf 1000 W.V.D.C.	K23010-10
C140	Fixed, silver mica, 15 mmf 300 W.V.D.C.	K23006-35



## PARTS LIST HQ-170 (Cont'd)

SCHEMATIC DESIGNATION	DESCRIPTION	HAMMARLUND PART NO.
<b>SPECIAL ASSEMBLIES</b>		
- CMC M1 Y1 Y2 Z1 Z2	Crystal panel, clock window Clock, Telechron auto-timer Meter "S" (carrier level) Quartz crystal, 2.580 Mcs Quartz crystal, 100.0 Kcs RC printed network (Calibrator) RC printed network (Audio)	M38877-1 K38874-1 K26149-5 K38972-2 K38861-1 K38981-1 K38846-1
<b>COILS</b>		
L1 L2 L3 L4 L5, L7 L6 L8 L9	RF Choke, 2.5 millihenry Bifilar Coil Slot Filter Coil Passband Tuning Coil RF Choke, 330 millihenries Filter Choke, 8.0 henries RF Choke, 38 microhenries RF Choke, 240 microhenries	K15627-1 K42032-1 K42034-1 K26301-1 K42019-1 K26302-1 K15629-1 K15629-2
<b>RESISTORS</b>		
R1, R30, R32, R37 R46, R76, R85 R2, R13, R27, R40, R51 R74, R91 R3, R4 R5, R14 R6 R7, R29, R36, R8, R98 R9, R12, R16, R17 R47, R52, R62, R97 R10, R42, R49, R65 R70, R72, R73, R75, R99 R84 R11 R15 R18 R19 R20 R21 R22 R23, R44 R24 R25 R26 R28, R43, R45, R48 R68, R71 R31, R33 R34 R35 R38 R39 R41, R95 R53 R54 R55 R56 R57 R58 R59, R63, R69 R60, R61, R66, R67 R64 R77 R78 R79 R80 R81 R82, R83, R93 R86 R87 R88 R89 R90 R92 R94 R96	470k ohms, 1/2 w., 10% 100k ohms, 1/2 w., 10% 10 ohms, 1/2 w., 10% 180 ohms, 1/2 w., 5% Variable 1.5k ohms, dual with R15 and S3 22k ohms, 1/2 w., 10% 160 ohms, 1/2 w., 5% 1k ohms, 1/2 w., 10% 47k ohms, 1/2 w., 10% 4.3K ohms, 1/2 w., 5% Variable 10k ohms, part of R6 100k ohms, 1 w., 10% Variable 1.5k ohms, meter sensitivity adj. Variable, 300 ohms, meter zero adj. 22k ohms, 1 w., 10% 750 ohms, 1/2 w., 5% 1 megohm, 1/2 w., 10% 120 ohms, 1/2 w., 5% 39 ohms, 1/2 w., 5% Variable, 200 ohms 220k ohms, 1/2 w., 10% 68 ohms, 1/2 w., 10% 560 ohms, 1/2 w., 10% 1k ohms, 1 w., 10% 150k ohms, 1/2 w., 10% 820 ohms, 1/2 w., 10% 10k ohms, 1/2 w., 10% 3k ohms, 10 w., 10% 680 ohms, 1/2 w., 10% 3k ohms, 1/2 w., 5% 15k ohms, 1/2 w., 10% 6.8k ohms, 1/2 w., 10% 27k ohms, 2 w., 10% 2.2k ohms, 1/2 w., 10% 330k ohms, 1/2 w., 10% 270 ohms, 1/2 w., 10% 47 ohms, 1/2 w., 10% Variable, 500k Variable 1 megohm 100 ohms, 1/2 w., 10% 1.5k ohms, 1 w., 10% 4.7 megohms, 1/2 w., 10% 430 ohms, 1 w., 5% 470 ohms, 1/2 w., 10% 2.7k ohms, 1/2 w., 5% 24k ohms, 1/2 w., 5% 15k ohms, 1/2 w., 5% 5.6k ohms, 1/2 w., 10% 68 ohms, 1/2 w., 5% 4.7k ohms, 1/2 w., 10%	K19309-113 K19309-97 K19309-1 K19309-260 K38940-1 K19309-81 K19309-199 K19309-49 K19309-89 K19309-213 K19310-97 K15379-2 K15379-1 K19310-81 K19309-206 K19309-121 K19309-258 K19309-253 K15368-7 K19309-105 K19309-21 K19309-43 K19310-49 K19309-101 K19309-47 K19309-73 K19337-2 K19309-45 K19309-212 K19309-77 K19309-69 K19304-52 K19309-57 K19309-109 K19309-35 K19309-17 K15378-3 K26218-3 K19309-25 K19310-53 K19309-137 K19310-212 K19309-41 K19309-272 K19309-219 K19309-168 K19309-67 K19309-256 K19309-65



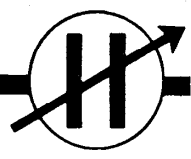

## PARTS LIST HQ-170

SCHEMATIC DESIGNATION	DESCRIPTION	HAMMARLUND PART NO.
<b>SWITCHES</b>		
S1	Noise Limiter ON-OFF (part of R78)	
S2A	Switch wafer, Ant. primary	K38952-1
S2B, C	Switch wafer, Ant. sec, RF sec	K38952-2
S2D	Switch wafer, RF tap	K38952-3
S2E	Switch wafer, HF Osc Tank	K38991-3
S2F	Switch wafer, HF Osc. tap	K38952-6
S3	AC ON-OFF (part of R6 and R15)	
S4	Send-Receive-Calibrate	K26306-1
S5	Selectivity	K26296-1
S6	Sideband	K26303-1
S7	AM-SSB/CW	K42037-2
S8	AVC	K26309-1
<b>TRANSFORMERS</b>		
T1	IF transformer, Composite 1st and 2nd IF	K26402-1
T2	IF transformer, Composite 1st and 2nd IF	K26402-1
T3	IF transformer, 455 Kcs	K38829-2
T4, T5	IF transformer, 455 Kcs	K38946-1
T6, T7, T8, T9, T10, T11	IF transformer, 60 Kcs	M42005-1
T12	Antenna transformer, 1.8 to 2.0 Mcs	K38926-1
T13	Antenna transformer, 3.5 to 4.0 Mcs	K38927-1
T14	Antenna transformer, 7.0 to 7.3 Mcs	K38928-1
T15	Antenna transformer, 14.0 to 14.4 Mcs	K38929-1
T16	Antenna transformer, 21.0 to 21.6 Mcs	K38930-1
T17	Antenna transformer, 28.0 to 30.0 Mcs	K38931-1
T18	Antenna coil, 50.0 to 54.0 Mcs	K26338-1
T19	RF transformer, 1.8 to 2.0, 3.5 to 4.0 Mcs	K38932-1
T20	RF transformer, 7.0 to 7.3, 14.0 to 14.4 Mcs	K38933-1
T21	RF transformer, 21.0 to 21.6 28.0 to 30.0 Mcs	K38934-1
T22	RF coil, 50.0 to 54.0 Mcs	K38944-2
T23	Osc transformer, 1.8 to 2.0, 3.5 to 4.0 Mcs	K38935-2
T24	Osc transformer, 7.0 to 7.3, 14.0 to 14.4 Mcs	K38936-2
T25	Osc transformer, 21.0 to 21.6, 28.0 to 30.0 Mcs	K38937-2
T26	Osc coil, 50.0 to 54.0 Mcs	K38945-3
T27A	Power transformer, 117V A.C.	P26305-1
T27B	Power transformer, 115-230V A.C., Export Model	P26305-2
T28	BFO transformer, 60 Kcs	M42005-4
T29	Audio Output transformer	K38828-1
<b>MISCELLANEOUS</b>		
E1	Fuse, holder	K15923-1
F1	Fuse, 3 Amp. type 3AGC	K15928-8
I1, I2, I3	Lamp, pilot, No. 47, 6.3 V., 15A	K16004-1
J1	External Relay Receptacle	K35013-1
J2	Phone Jack	K35608-1
	Steel Cable Assembly	26339-G1
	Spring	38895-1
	Antenna Trimmer Cord	K42067-3
<b>OPTIONAL ACCESSORIES</b>		
	Telechron Clock Assembly Conversion Kit including instructions for converting model HQ-170 to Model HQ-170C	PL26380-G1
	Loudspeaker assembly in cabinet matched to the Models HQ-170, HQ-170C and HQ-170E	PL26394-G1

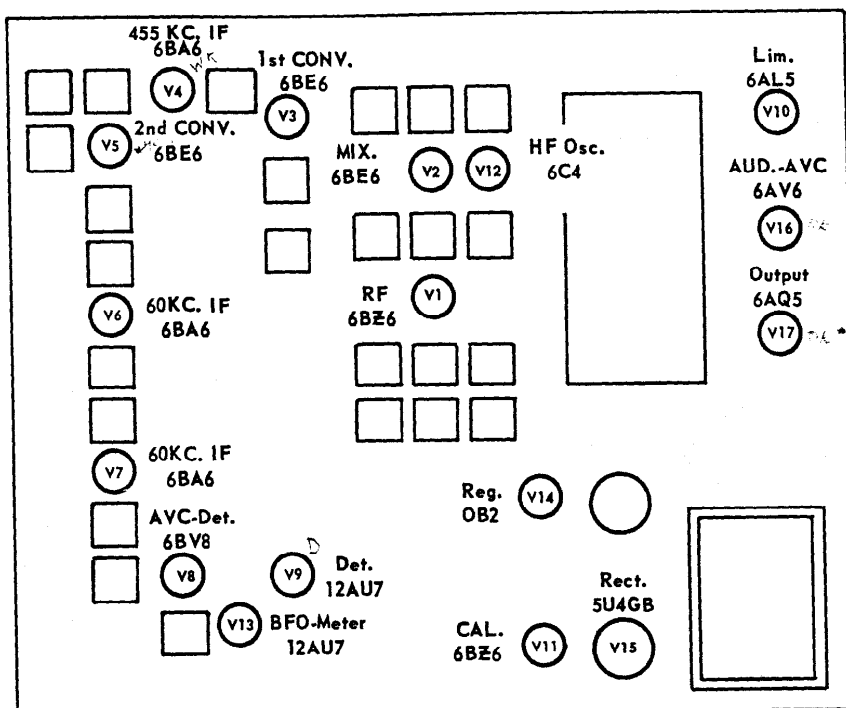

REAR

Figure 13. Tube Location Diagram

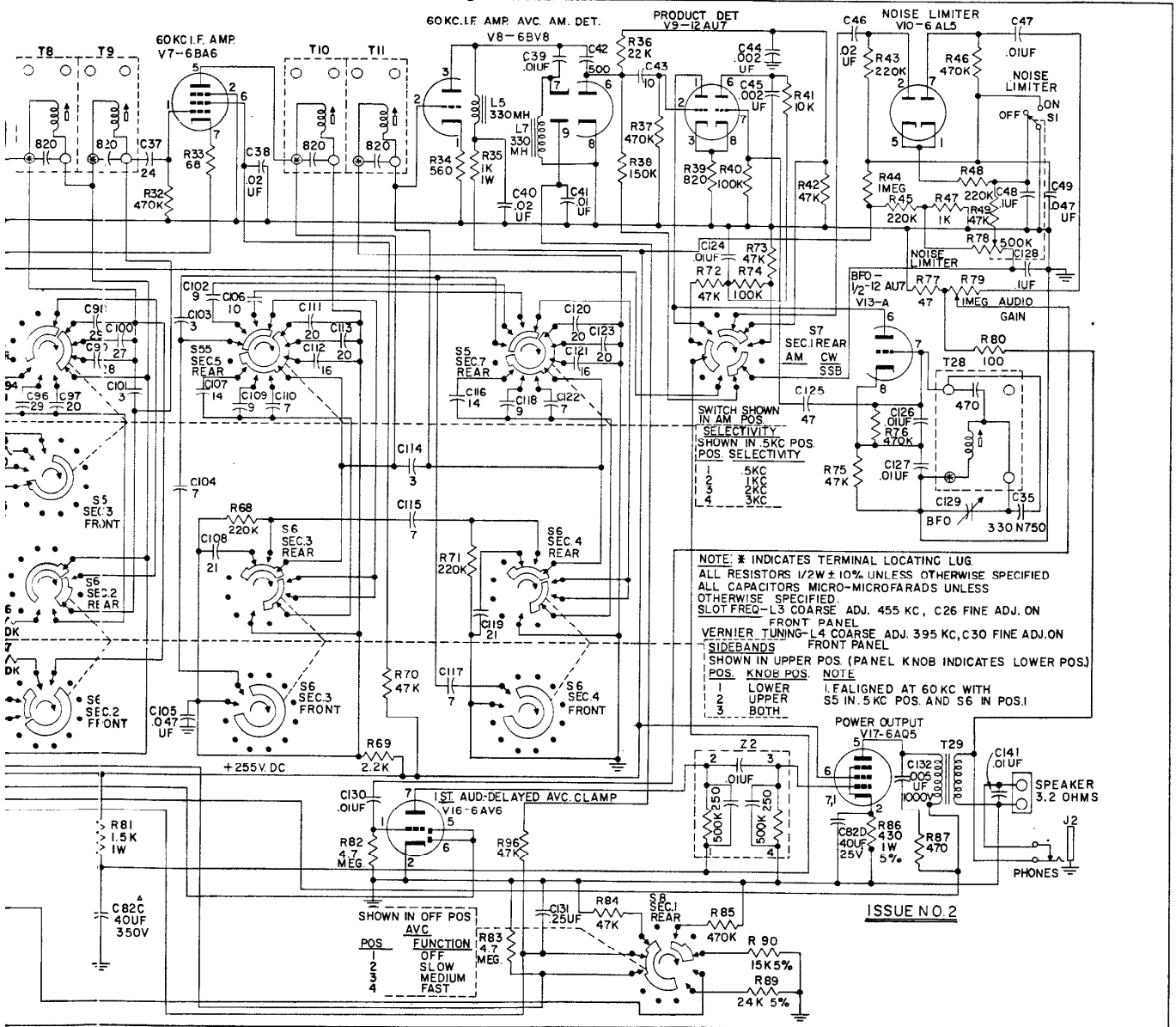

Figure 14. Hammarlund HQ-170 Communications Receiver, Schematic Diagram

